



MeterMinder w/ CareTaker Plus Security Installation Guide

46-481-B September, 1992

Welcome to MeterMinder

MeterMinder is a dual-purpose panel that offers a utility company the convenience of on-site meter reading and member home security functions. Included in this demonstration package are security devices to enhance your MeterMinder system with security system features. Refer to page 10 for more information on security functions for MeterMinder.

Table of Contents

About the System	Pg 1
How it Works	1
Meter Minder Specs.	2
Installation	2
Mounting	2
CPU Board Components	4
Connecting Power	5
Connecting Phone lines	5
Connecting Electric Meters	6
Wiring Diagram	7
Powering Up the CPU	8
Startup CPU Programming	8
Adding Security Features	10
Product Update	11

About the System

The MeterMinder System is comprised of the ITI MeterMinder Control Panel connected to a maximum of three on-site single phase electric meters.

How it Works

The MeterMinder panel automatically reads the electric meters it is connected to, records this data and calls in to the Central Monitoring Station receiver with a report at preprogrammed intervals. The report consists of the meter's account number, the latest pulse count and the Watts per revolution value.

The Central Station receiver then downloads the MeterMinder panel with the correct time and the number of days to count off before the MeterMinder panel calls in again. The Central Station receiver converts the pulse count to the meter kilowatt-hour reading. It then transfers the data either to a personal computer for storage and later transmission to a mainframe, or the data is transmitted directly to a mainframe.

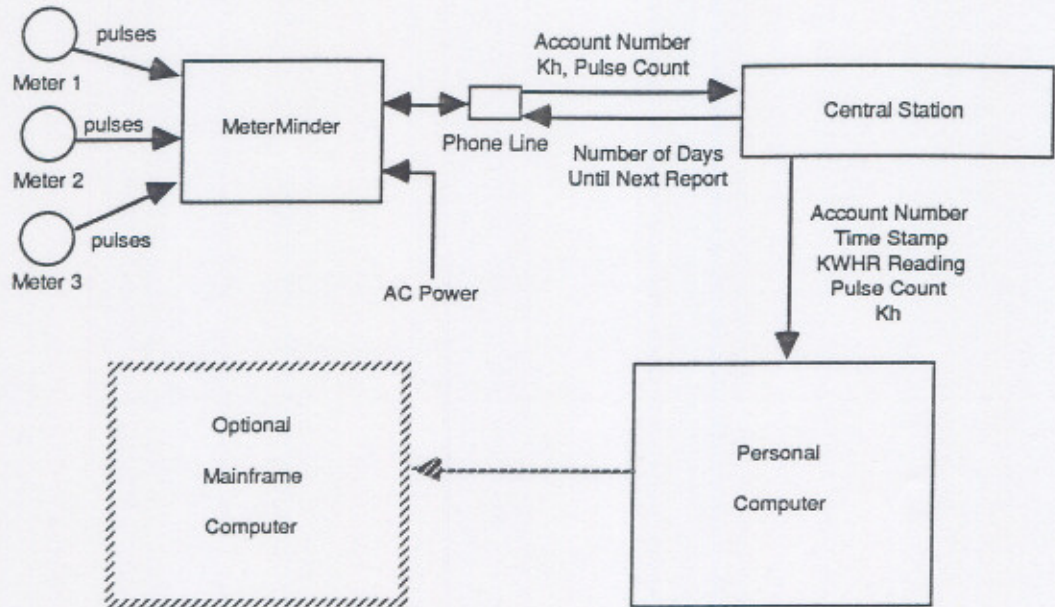

MeterMinder Specifications

- Microprocessor based circuit board
- Dimensions: 2"d x 13"w x 10"h add 9" for antennas
- Plastic Cover with Tamper Feature
- Temperature Range: 42° to 95°F
- Digital Communicator (Bell 103 format)
- Uses a 9Vac 15 Va AC Transformer
- Rechargeable Standby Battery
6 volt 3.2 amp hour
24 hour typical standby time
- Current Draw
CPU - 50 mA

Installation

Preliminary Considerations

In General:

- Locate the CPU in a controlled temperature environment (42° to 95 F).
- Locate the CPU near the residence's meters, if possible. If the utility member is interested in the optional security features of the MeterMinder, centrally locate the CPU with respect to all security sensors. See the CareTaker Plus Installation manual for more detail on where to locate the CPU for security purposes.
- Verify the availability of a 110 VAC non-switched outlet for the power transformer.
- Verify access to incoming telephone lines.

Using the Meter Read Inputs (Terminal Strip 1):

- Use 18 to 22 gauge three conductor shielded wire.
- Don't run wires parallel to AC power or fluorescent lighting.
- Use end-of-line resistors to detect either a cut wire between the meter and MeterMinder or an open socket cover.
- Maximum loop resistance of the wire runs should not exceed 100 ohms (without resistors).

Mounting

1. Remove CPU cover by loosening the 3 screws on the chassis bottom and swing cover out and up to remove from catches on chassis top.
2. Disconnect and remove backup battery from the CPU.
3. Remove any wiring knockouts needed. **BE CAREFUL NOT TO DAMAGE THE CIRCUIT BOARD.**
4. Place the CPU chassis against the wall and mark the 2 keyhole and 2 mounting hole locations.
5. If mounting to studs, use at least #8 x 1&1/4" long screws. If mounting holes line up between studs, use appropriate anchors and screws.

6. Partially insert screws into anchors at keyhole locations, then hang the CPU chassis on them.
7. Partially insert the two lower screws. Make sure chassis is level, then tighten all screws.



CAUTION!

It is important to be free of static electricity whenever working with the CPU cover removed. Be sure to discharge any static by first touching the metal CPU chassis and stay in contact with the chassis when touching the circuit board. Use of an approved grounding strap is recommended.

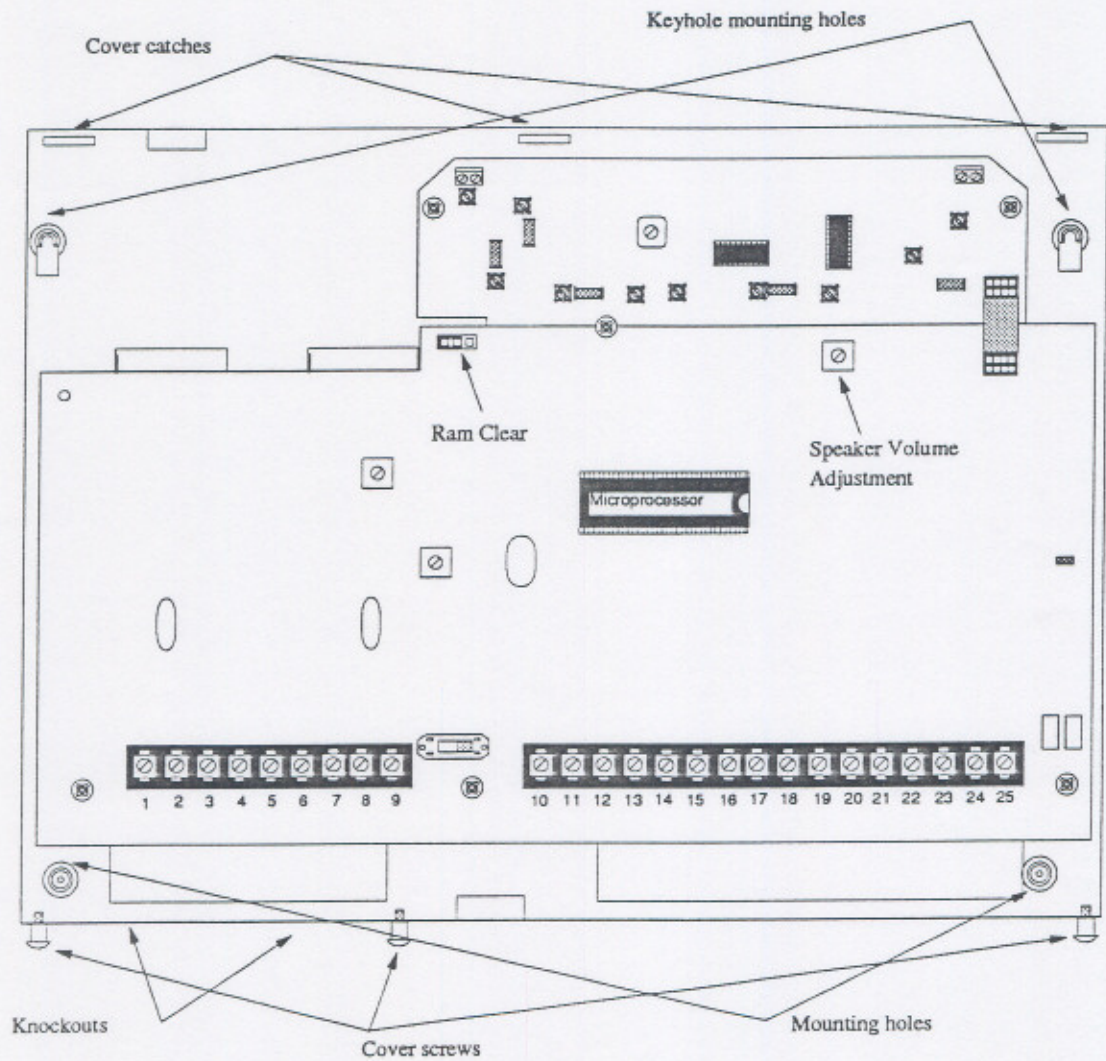

CPU Board Components

After mounting the chassis, study the following diagram and descriptions of the MeterMinder CPU board components.

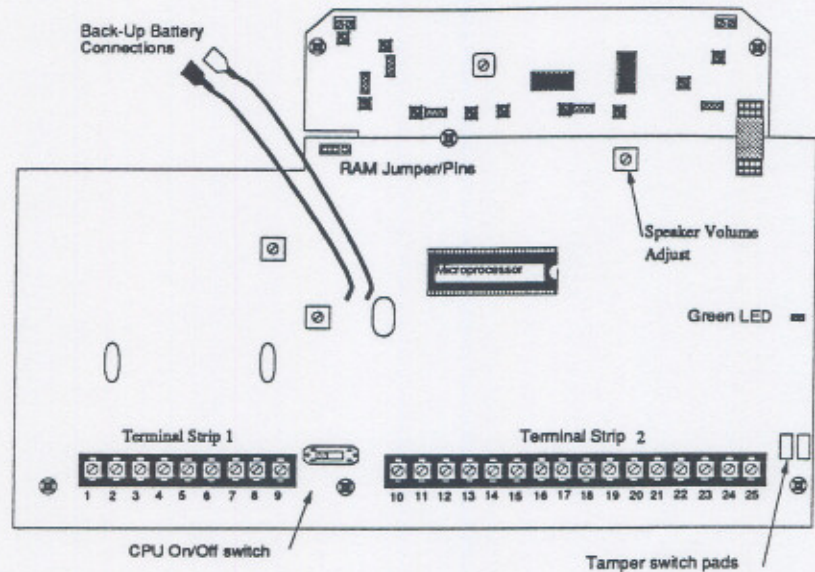

TERMINAL STRIP 1

- Provides connections for 3 Meters.

TERMINAL STRIP 2

Provides connections for the following:

- AC Power Transformer
- Phone Line

POWER INDICATOR (GREEN LED)

<i>STATUS</i>	<i>CONDITION</i>
ON	Normal
Flashing	AC Power Failure, CPU is operating on backup battery.
OFF	CPU Power Switch is OFF or major failure occurred.

MEMORY CLEAR JUMPER

- Refer to page 8 under Startup CPU Programming section.

CPU POWER SWITCH

- ON – CPU is operational.
- OFF – CPU is OFF. CPU Memory is retained indefinitely in EEPROM. Battery charge circuit remains activated when transformer is plugged in.

SPEAKER VOLUME ADJUSTMENT POT

- Clockwise – Decrease CPU speaker volume.

NOTE:

If there are no security features used with the MeterMinder it is recommended that the volume on the speaker be decreased fully.

Connecting Power, Phone lines, and Electric Meters

The following instructions describe CPU connections for power, phone lines, and Electric Meters. All connections to the CPU must be made with the power OFF and back-up battery disconnected. The CPU Power Up procedure is located on page 8, with Startup CPU Programming.

Power

Connect the 9Vac 15 Va Transformer

1. Be sure the CPU Power switch is OFF and back-up battery is disconnected.
2. Connect the 9Vac Transformer supplied with the MeterMinder as follows:
 - Using two wires, connect one to CPU terminal 13 (AC) and one to CPU terminal 14 (AC).
 - Then connect the wires to the two terminals on the transformer.
3. Locate transformer by a 24 hour non-switched AC outlet, DO NOT plug transformer in at this time.

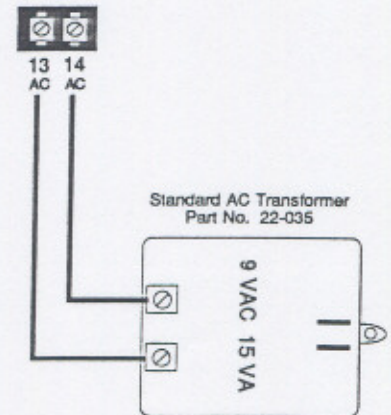

Phone Lines

1. Connect the DB-8 cord to the CPU
 - DB-8 Cord Green to Terminal 22 (T)
 - DB-8 Cord Brown to Terminal 23 (T1)
 - DB-8 Cord Gray to Terminal 24 (R1)
 - DB-8 Cord Red to Terminal 25 (R)
2. Secure the DB-8 cord strain relief to the CPU chassis using the screw in the lower right corner of the CPU board.
3. Connect Four conductor wire run from RJ-31X jack to Telco Protector Block, as shown below.
4. Plug DB-8 connector into the RJ-31X Jack receptacle.

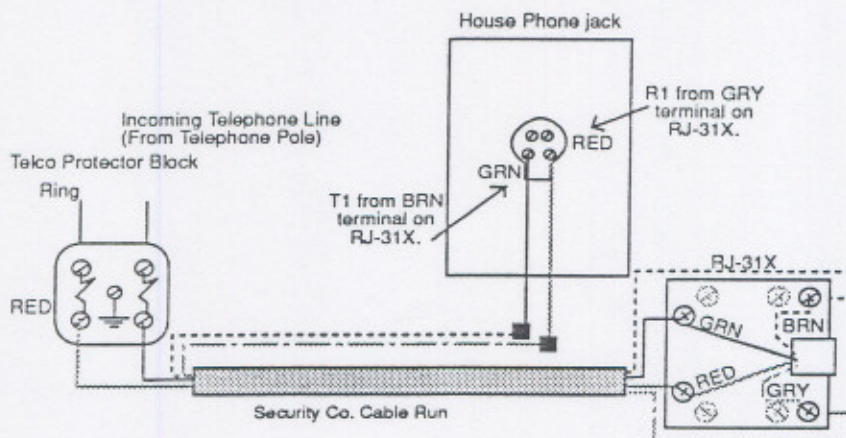
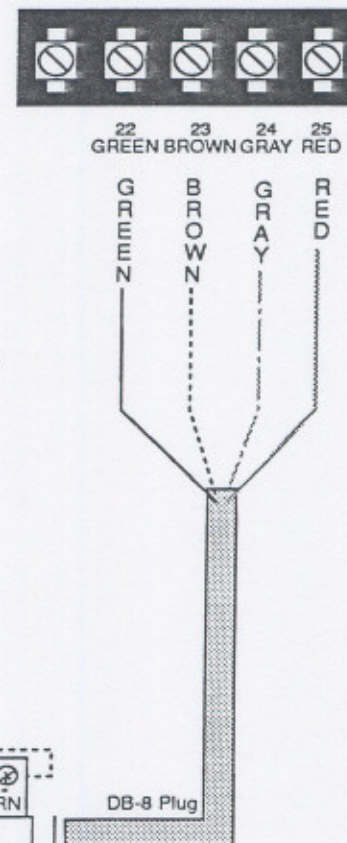

TROUBLESHOOTING: If there is no dial tone on the phone after wiring the RJ-31X jack or no dial tone after plugging in the DB-8 cord, check for:

- Improper wiring of RJ-31X jack. See page 5 to correct.
- Improper wiring of DB-8 cord to CPU terminals. See page 5 to correct.
- Defective RJ-31X jack. Replace jack.
- Defective DB-8 cord. Replace cord.

- NOTES:**
- To prevent accidental interruption of the utility member's phone service, verify that phone connections are correct.
 - Reporting from the MeterMinder to the Central Station will be delayed if the phone is off hook. Also, reports in progress will be interrupted if the phone is taken off the hook.
 - Reports to phone #2, #3 or #4 will not begin immediately if the phone is off hook. The report will occur when the phone is hung up or 1 hour passes, whichever occurs first. If the phone is hung up, there will be a ten second delay before reporting.
 - Reports to phone #2, #3 or #4 will be interrupted if a security report to phone #1 occurs or the phone is taken off hook.

Once the security report is completed or the phone is hung up, the MeterMinder will redial the report that was interrupted.

Electric Meters

There are two types of Electric Meters for use with the MeterMinder CPU.

KYZ METERS

The first is a KYZ meter with output terminals that are wired directly to the MeterMinder inputs on terminal strip #1. Resistors are installed across the meter inputs to supervise the wiring from the meter to the CPU. A Normally open switch may be installed in series with one of the output lines to provide for tamper alarm when the meters socket cover is opened.

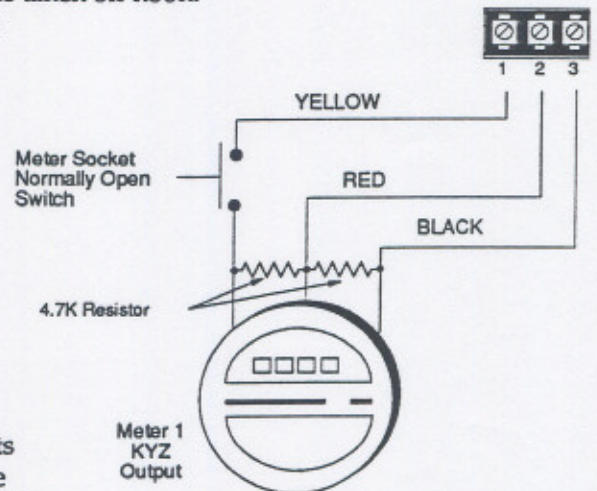

OPTICAL METERS

The second type of meter is a Meter equipped with an optical sensor. It has output terminals that are wired directly to inputs on terminal strip #1 and terminal strip #2. These meters require modification by adding an optical sensor device to read the disk revolutions in the meter. After installing the optical sensor device, wire the meter and add resistors as shown.

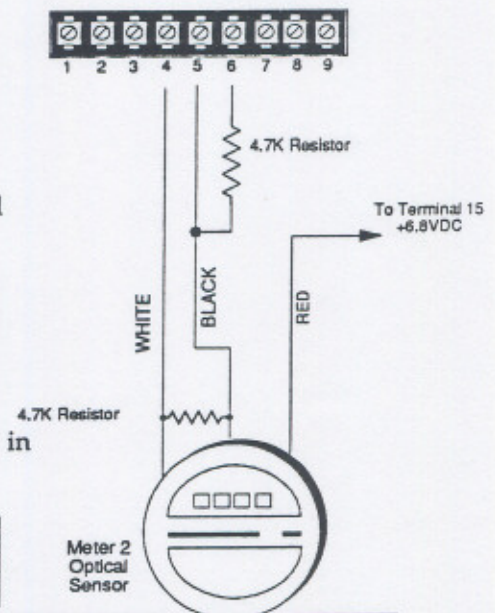

NOTE: If the meter is not equipped with an optical sensor, contact Duane Paulson at Interactive Technologies ((612) 777-2690) for retrofit information.



CAUTION!

DO NOT use hardwire security devices on terminal strip #1 in conjunction with meter reading functions.

NOTE: Terminal groups 1, 2, 3 or 4, 5, 6 or 7, 8, 9 can support either type of meter as described above.

MeterMinder Wiring Diagram

The diagram below shows wiring connections for all the devices covered earlier in this manual.

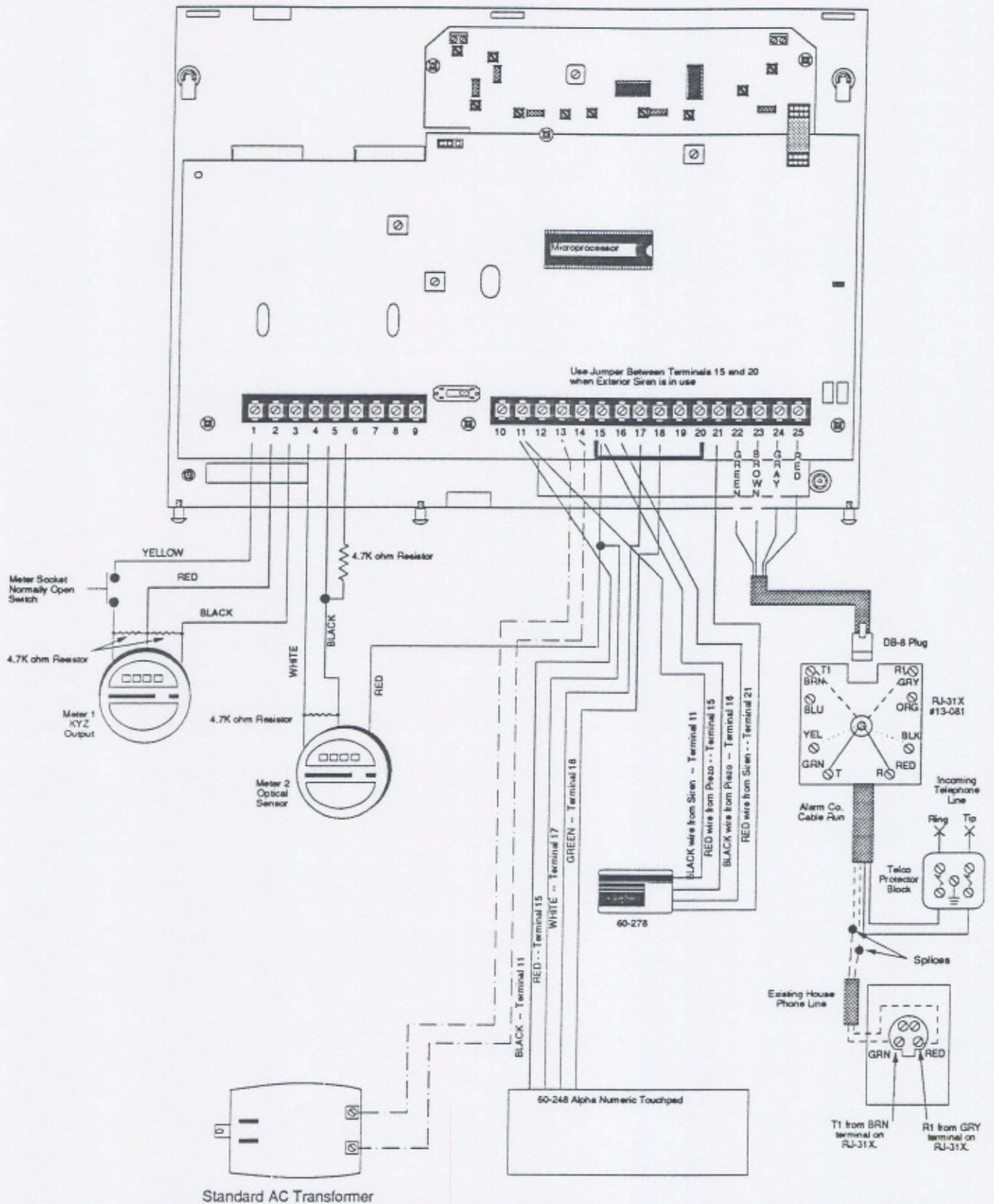

Powering Up the CPU

1. Be sure the CPU power switch is OFF. Connect the red and black flying leads to the back-up battery. Observe polarity.
2. Plug the transformer into a non-switched AC outlet. Turn the CPU power switch ON. The green LED at the middle right side of the CPU should light up.

TROUBLESHOOTING: If the CPU doesn't power up, immediately turn the CPU power switch OFF. Then,

- Check that power transformer is plugged in and secured to the non-switched outlet with the set screw provided.
- Check for proper wire terminations at the CPU and power transformer.
- Use a voltmeter to check the incoming voltage at the CPU terminals. Voltage at terminals 13 and 14 should be at least 9VAC.

Startup CPU Programming

1. Clear CPU Memory

It is important to clear the CPU memory to remove any factory programming that may be left in the CPU's memory.

Procedures:

- (a) Remove the memory clear jumper at the top and middle of the CPU board.
- (b) Reposition the jumper on the right two pins for at least five seconds to clear the CPU's memory.
- (c) Replace the jumper on the left two pins.
- (d) If security features are needed with this system program them at this time. Refer to CareTaker Plus Installation manual to program security features.
- (e) Before continuing, the CPU cover must be replaced.

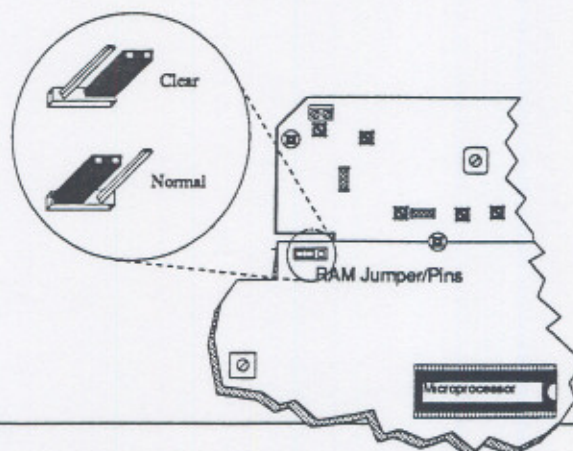

2. Using an on-premise phone, call the Central Monitoring Station that is servicing the account.

When a Central Station operator is on the line, instruct them to program the MeterMinder over the phone. After talking with the operator, hang up the phone.

TROUBLESHOOTING: If there is no dial tone when attempting to dial the Central Station, this indicates there are polarity sensitive phones on the premises. Reverse the wires connected to the Brown and Gray terminals on the RJ-31X jack.

3. Have Central Station call you back using their programming line. When on premise phone rings pick up phone and wait for a hand shake from Central Station, then press * 1234 #0 on the telephone touchpad.

The phone line should go "dead". This indicates the CS-4000 CPU is interactive with the MeterMinder.

4. Hang up the phone.

The MeterMinder is now being programmed with, among other items, an Account Number, day of the month for monthly reporting, delay time before reporting power outage, meter pulse sampling frequency, initial Kh value, phone numbers 2 (for monthly meter reports), phone number 3 (for usage history) and phone number 4 (for reporting power outages). Other functions may be programmed into the MeterMinder depending on the utility's requirements.

5. Confirm successful programming (Optional)

Pick up the phone after a short wait. If there is a dial tone, programming is complete. If desired, call back the Central Station operator to confirm successful programming.

Adding Security Features to the MeterMinder

Since MeterMinder is a dual-purpose meter reading and security system, CareTaker Plus security features and devices can be added at this time if the utility member wants them.

Security system programming information can be found in the HiTech Hardwire Touchpad installation manual. Remember to read the CareTaker Plus installation manual prior to connecting any security system features.

Some CareTaker Plus security features and devices are:

Features

- Telephone control of the CareTaker Plus security functions in the MeterMinder.
- Multiple arming levels with adjustable delay times.
- Voice annunciation of alarms.

Features – can be added by the installer without assistance from the Central Station by using the Alphanumeric Hardwire Touchpad. Refer to the *Alphanumeric Touchpad Manual* for detailed instructions on programming features.

Devices

- Security Sensor Monitoring (perimeter, intrusion, panic, and environmental).
- Several siren and speaker options.

Devices – can be added by the installer, but be sure to read the *CareTaker Plus Installation Manual* prior to connecting any security system device.

IMPORTANT!

Keep in mind that this document refers to the CareTaker Plus Installation manual, and that the CareTaker Plus manual depicts a CPU with 26 terminals. The MeterMinder has only 25 terminals, follow the MeterMinder Wiring Diagram on page 7 of this document for correct terminal connection.

If you have any difficulties in installing, programming, or operating the demonstration equipment, please call ITI Technical Services at (800) 777-2624.

Product Update

Daughter Board

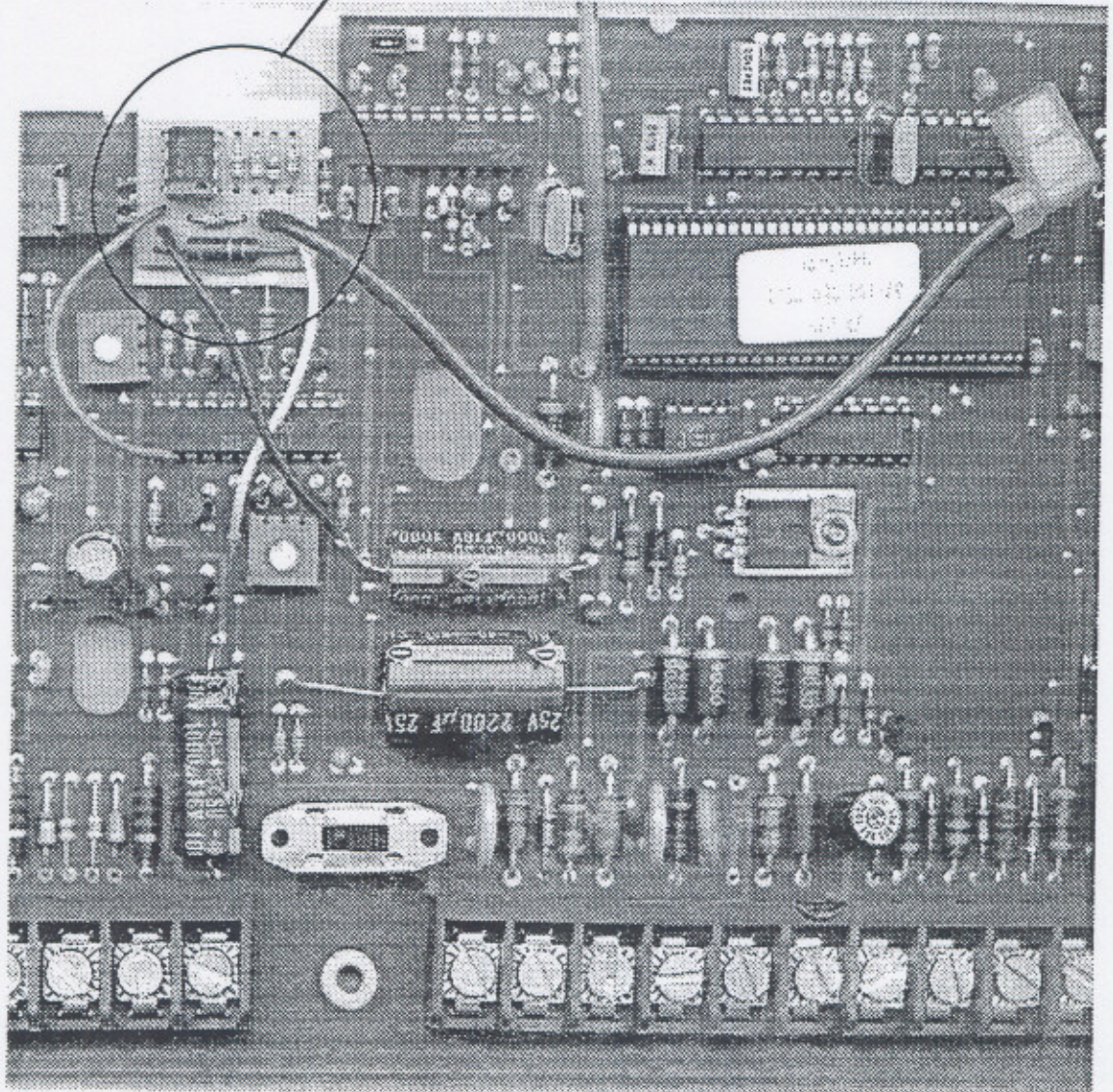

The small circuit board (Daughter Board) is installed to provide a 500mA continuous charging current supplied to the Back-up Battery (with AC connected).